



Bonfiglioli

Vectron

ACTIVE and ACTIVE Cube

Expansion Module EM-RES-02
Frequency Inverter 230V / 400V



General points on the documentation

The present supplement of the documentation is valid for the frequency inverter series ACT and ACU. The information necessary for the assembly and application of the EM-RES-02 expansion module is documented in this guidance.

For better clarity, the user documentation is structured according to the customer-specific demands made of the frequency inverter.

Brief instructions

The brief instructions describe the fundamental steps for mechanical and electrical installation of the frequency inverter. The guided commissioning supports you in the selection of necessary parameters and the software configuration of the frequency inverter.

Operating instructions

The operating instructions document the complete functionality of the frequency inverter. The parameters necessary for specific applications for adaptation to the application and the extensive additional functions are described in detail.

Application manual

The application manual supplements the documentation for purposeful installation and commissioning of the frequency inverter. Information on various subjects connected with the use of the frequency inverter is described specific to the application.

Installation instructions

The installation instructions describe the mechanical installation and use of devices which differ from those described in the brief instructions and the operating instructions.

The documentation and additional information can be requested via your local representation of the company BONFIGLIOLI.

The following pictograms and signal words are used in the documentation:



Danger!

means a directly threatening danger. Death, serious damage to persons and considerable damage to property will occur if the precautionary measure is not taken.



Warning!

marks a possible threat. Death, serious damage to persons and considerable damage to property can be the consequence if attention is not paid to the text.



Caution!

refers to an indirect threat. Damage to people or property can be the result.

Attention!

refers to a possible operational behavior or an undesired condition, which can occur in accordance with the reference text.

Note

marks information, which facilitates handling for you and supplements the corresponding part of the documentation.



Warning! In installation and commissioning, comply with the information in the documentation. You as a qualified person must have read the documentation carefully and understood it. Comply with the safety instructions. For the purposes of the instructions, "qualified person" designates a person acquainted with the erection, assembly, commissioning and operation of the frequency inverters and possessing the qualification corresponding to the activity.

TABLE OF CONTENTS

1	General safety and application information	3
1.1	General information.....	3
1.2	Proper use.....	3
1.3	Transport and storage	4
1.4	Handling and positioning.....	4
1.5	Electrical connection.....	4
1.6	Operation information	4
1.7	Maintenance and service	4
2	Introduction	5
3	Installation of the EM-RES-02 expansion module	6
3.1	General	6
3.2	Mechanical installation	6
3.3	Electrical installation	8
3.3.1	Circuit diagram	8
3.3.2	Control Sockets	9
4	Control inputs and outputs	10
4.1	Analog input EM-S1INA	10
4.1.1	General.....	10
4.1.2	Configuration voltage/current input	10
4.1.3	Characteristic	11
4.1.4	Operation modes	11
4.1.4.1	Examples.....	12
4.1.5	Scaling.....	14
4.1.6	Tolerance band and hysteresis.....	15
4.1.7	Error and warning behavior	16
4.1.8	Adjustment	17
4.1.9	Filter time constant.....	17
4.2	Resolver input EM-RES	18
4.2.1	Offset.....	18
4.2.2	Actual speed source.....	21
4.3	Frequency and percentage reference channel	21
4.4	Actual value display.....	22
4.5	Repetition frequency output EM-RFOUT	22
5	Parameter list.....	23
5.1	Actual value menu (VAL)	23
5.2	Parameter menu (PARA)	23
6	Annex	24
6.1	Error messages	24

1 General safety and application information

This documentation has been created with greatest care and has been extensively and repeatedly checked. For reasons of clarity, we have not been able to take all detailed information on all the types of the products and also not every imaginable case of positioning, operation or maintenance into account. If you require further information or if particular problems not treated extensively enough in the operating instructions occur, you can obtain the necessary information via the local representation of the company BONFIGLIOLI.

In addition, we would point out that the contents of these operating instructions are not part of an earlier or existing agreement, assurance or legal relationship, nor are they intended to amend them. All the manufacturer's obligations result from the purchase contract in question, which also contains the completely and solely valid warranty regulation. These contractual warranty provisions are neither extended nor limited by the implementation of these operating instructions.

The manufacturer reserves the right to correct or amend the contents and product information as well as omissions without specific announcement and assumes no kind of liability for damage, injuries or expenditure to be put down to the aforementioned reasons.

1.1 General information



Warning! BONFIGLIOLI VECTRON frequency inverters have high voltage levels during operating, depending on their protection class, drive moving parts and have hot surfaces.

In the event of inadmissible removal of the necessary covers, improper use, wrong installation or operation, there is the risk of serious damage to persons or property.

To avoid the damage, only qualified staff may carry out the transport, installation, setup or maintenance work required. Comply with the standards EN 50178, IEC 60364 (Cenelec HD 384 or DIN VDE 0100), IEC 60664-1 (Cenelec HD 625 or VDE 0110-1), BGV A2 (VBG 4) and national provisions. Qualified persons within the meaning of this principal safety information are people acquainted with the erection, fitting, commissioning and operating of frequency inverters and the possible hazards and in possession of qualifications matching their activities.

1.2 Proper use



Warning! The frequency inverters are electrical drive components intended for installation in industrial plant or machines. Commissioning and start of intended operation are not allowed until it has been established that the machine corresponds to the provisions of the EC machine directive 98/37/EEC and EN 60204. According to the CE sign, the frequency inverters additionally fulfill the requirements of the low-voltage directive 73/23/EEC and the standards EN 50178 / DIN VDE 0160 and EN 61800-2. Responsibility for compliance with the EMC directive 89/336/EEC is with the user. Frequency inverters are available in a limited way and as components exclusively intended for professional use within the meaning of the standard EN 61000-3-2.

With the issue of the UL certificate according to UL508c, the requirements of the CSA Standard C22.2-No. 14-95 have also been fulfilled.

The technical data and the information on connection and ambient conditions stated on the rating plate and the documentation must be complied with. The instructions must have been read and understood before starting work at the device.

1.3 Transport and storage

Transport and storage are to be done appropriate in the original packing. Store the units only in dry rooms, which are protected against dust and moisture and are subjected to little temperature deviations only. Observe the climatic conditions according to standard EN 50178 and to the information on the label of the original packing. The duration of storage without connection to the admissible reference voltage may not exceed one year.

1.4 Handling and positioning



Warning! Damaged or destroyed components may not be put into operation because they may be a health hazard.

The frequency inverters are to be used according to the documentation, the directives and the standards. Handle carefully and avoid mechanical overload. Do not bend the components or change the isolation distances. Do not touch electronic components or contacts. The devices contain construction elements with a risk of electrostatic, which can easily be damaged by improper handling. Any use of damaged or destroyed components shall be considered as a non-compliance with the applicable standards. Do not remove any warning signs from the device.

1.5 Electrical connection



Warning! Before any assembly or connection work, de-energize the frequency inverter. Make sure that the frequency inverter is de-energized. Do not touch the sockets, because the capacitors may still be charged. Comply with the information given in the operating instructions and on the frequency inverter label.

While working on the frequency inverters, obey the applicable standards BGV A2 (VBG 4), VDE 0100 and other national directives. Comply with the information in the documentation on electrical installation and the relevant directives. Responsibility for compliance with and examination of the limit values of the EMC product standard EN 61800-3 for variable-speed electrical drive mechanisms is with the manufacturer of the industrial plant or machine.

The documentation contains information on installation correct for EMC. The cables connected to the frequency inverters may not be subjected to an isolation test with a high test voltage without previous circuit measures.

1.6 Operation information



Warning! Before commissioning and the start of the intended operation, attach all the covers and check the sockets. Check additional monitoring and protective devices pursuant to EN 60204 and the safety directives applicable in each case (e.g. Working Machines Act, Accident Prevention Directives etc.). No connection work may be performed, while the system is in operation.

1.7 Maintenance and service



Warning! Unauthorized opening and improper interventions can lead to physical injury or damage to property. Repairs on the frequency inverters may only be done by the manufacturer or persons authorized by the latter.

2 Introduction

This document describes the possibilities and the properties of the EM-RES-02 expansion module for the frequency inverters of the ACT and ACU device series.

Note: This document exclusively describes the EM-RES-02 expansion module. It is not to be understood as fundamental information for the operation of the frequency inverters of the ACT and ACU device series.

The EM-RES-02 expansion module is an optional hardware component to extend the functionality of the frequency inverter. It enables the data exchange within the network between the components which have been directly connected, for example control and regulation elements.

The EM-RES-02 expansion module is supported from device series ACU and as from software version 4.1.0 of device series ACT.

The EM-RES-02 module extends the functionality of the frequency inverters of the ACT and ACU device series by the following additional functions:

- **Analog input**
(second bipolar analog input)
- **Resolver input**
- **Repetition frequency output**

Note: The EM-RES-02 expansion module has been enclosed with the frequency inverter as a separate component and must be fitted by the user. This is described in detail in the chapter "Mechanical Installation".

To assemble the expansion module it can be simply plugged into the frequency inverter of the ACT and ACU device series.



Warning! The assembly is done before the frequency inverter is put into operation, and only in a voltage-free state.

The pluggable sockets of the expansion module enable economical overall fitting with a safe function.

3 Installation of the EM-RES-02 expansion module

3.1 General

The mechanical and electrical installation of the EM-RES-02 expansion module is to be carried out by qualified personnel according to the general and regional safety and installation directives. Safe operation of the frequency inverter requires that the documentation and the device specification be complied with during installation and start of operation. For specific areas of application further provisions and guidelines must be complied with where applicable.

The frequency inverters are designed according to the requirements and limit values of product standard EN 61800-3 with an interference immunity factor (EMI) for operation in industrial applications. The electromagnetic interference is to be avoided by expert installation and observation of the specific product information.

For further information, refer to the operating instructions of the frequency inverter.



Danger! All connection sockets where dangerous voltage levels may be present (e.g. motor connection sockets, mains sockets, fuse connection sockets, etc.) must be protected against direct contact.

3.2 Mechanical installation



Danger! If the following instructions are not complied with, there is direct danger with possible consequences of death or severe injury by electrical current. To disregard the instructions can lead to destruction of the frequency inverter and/or of the expansion module.

- Before assembly or disassembly of the EM-RES-02 expansion module, the frequency inverter must be de-energized. Take appropriate measures to make sure it is not energized unintentionally.
- Make sure that the frequency inverter is de-energized.



Danger! The mains, direct voltage and motor sockets can be live with dangerous voltage after disconnection of the frequency inverter. Work may only be done on the device after a waiting period of some minutes until the DC link capacitors have been discharged.

The EM-RES-02 expansion module is supplied in a housing for assembly on the lower slot of the frequency inverter.

- Remove the lower cover (1) of the frequency inverter.
The slot for the EM-RES-02 expansion module becomes accessible.

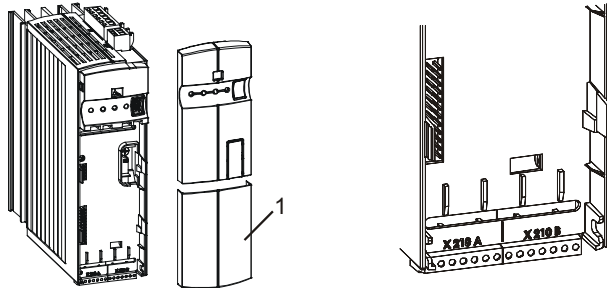

Caution! The EM-RES-02 expansion module (2) is pre-fitted in a housing. Do NOT touch the PCB visible on the back, as modules may be damaged.

- Plug the EM-RES-02 expansion module (2) onto the slot (3).

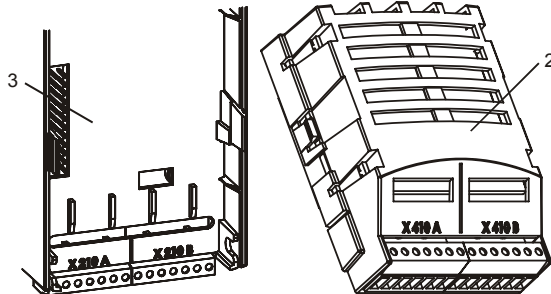

- Re-install the lower cover (1).
This completes the assembly procedure.

When the supply voltage of the frequency inverter is switched on, the EM-RES-02 expansion module is ready for operation.

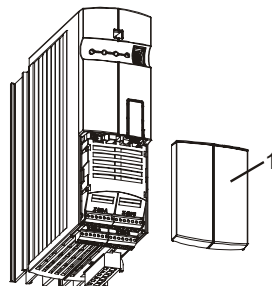

3.3 Electrical installation



Danger! If the following instructions are not complied with, there is direct danger with the possible consequences of death or severe injury by electrical current. Further, failure to comply can lead to destruction of the frequency inverter and/or of the expansion module.

- Before electrical installation of the EM-RES-02 expansion module, the frequency inverter must be de-energized. Take appropriate measures to make sure it is not energized unintentionally.
- Make sure that the frequency inverter is de-energized.



Danger! The mains, direct voltage and motor sockets can have dangerous voltages even after disconnection of the frequency inverter. Work may only be done on the device after a waiting period of some minutes until the DC link capacitors have been discharged.

3.3.1 Circuit diagram

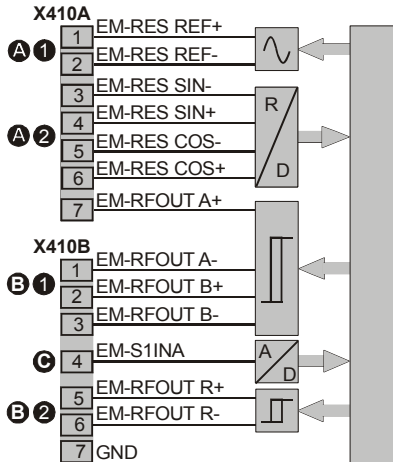

A Resolver interface EM-RES

A 1 Field voltage $U_{REF\ eff} = 4\ V$, $I_{max} = 60\ mA$

A 2 Input voltage $U_{min\ eff} = 2\ V$, voltage-proof until 30 V

The resolver interface is suitable for connecting commercial resolvers with the following specifications:

Input impedance $> 95\ \Omega$ at 5 kHz, 10 kHz, 20 kHz, no. of pole pairs: up to 24,

30 000 rpm at no. of pole pairs = 1

phase displacement (at field frequency): 7° (5 kHz), 14° (10 kHz), 26° (20 kHz)

B Repetition frequency output EM-RFOUT

B 1 Frequency signal, $f_{max} = 512\ kHz$, overload and short-circuit proof,

$I_{max} = \pm 60\ mA$ at min. permissible line termination 150 Ω ,

TTL (push-pull) according to specification RS-422A / RS-485: $U_{max} = 5\ V$

B 2 Reference signal

C Analog input EM-S1INA

Analog signal, resolution 12 Bit,

$U_{max} = \pm 10\ V$ ($R_i = 100\ k\Omega$), $I_{max} = \pm 20\ mA$ ($R_i = 250\ \Omega$)

3.3.2 Control Sockets

The control and software functionality can be freely configured for economical operation with a safe function.

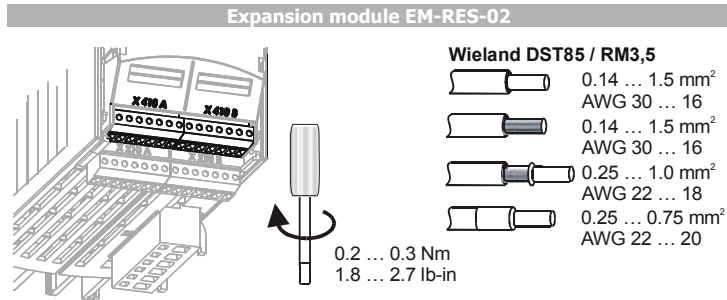

Caution! The control inputs and outputs must be connected and disconnected free of electrical power. Otherwise components may be damaged.

Attention! In order to minimize electromagnetic interference and to obtain a good signal quality:

- Use a shielded, pair-twisted (SIN+ with SIN-, COS+ with COS-, both field signal lines) cable for connecting the resolver.
- The line screen is to be connected to PE on a plane at both ends.

Socket X410A	
Ter.	Description
1	Resolver field signal EM-RES REF+
2	Resolver field signal EM-RES REF-
3	Resolver input EM-RES SIN-
4	Resolver input EM-RES SIN+
5	Resolver input EM-RES COS-
6	Resolver input EM-RES COS+
7	Repetition frequency output EM-RFOUT A+ ¹⁾

Socket X410B	
Ter.	Description
1	Repetition frequency output EM-RFOUT A- ⁻¹⁾
2	Repetition frequency output EM-RFOUT B+ ¹⁾
3	Repetition frequency output EM-RFOUT B- ¹⁾
4	Analog input EM-S1INA, resolution 12 bit, U _{max} = ±10 V (R _i = 100 kΩ), I _{max} = ±20 mA (R _i = 250 Ω)
5	Repetition frequency output EM-RFOUT R+
6	Repetition frequency output EM-RFOUT R-
7	Earth / GND

¹⁾ The repetition frequency output is interference voltage proof in a range between -5 V to +10 V.

4 Control inputs and outputs

4.1 Analog input EM-S1INA

4.1.1 General

The analog input of the EM-RES-02 expansion module can optionally be configured as a voltage or a current input. Parameterization of the input signal is done by the definition of a linear characteristic and assignment as a

- reference value source
(can be selected via the parameter *Reference frequency source* **475**),
- reference percentage source
(can be selected via the parameter *Reference percentage source* **476**),
- actual percentage source
(can be selected via the parameter *Actual percentage source* **478**, in configuration **x11**) or
- limit value sources
(can be selected via the parameters **734...737**).

4.1.2 Configuration voltage/current input

The analog input of the EM-RES-02 expansion module has been configured in the factory setting for a voltage signal of +/- 10 V. Switch **S3** enables a switch-over of the operation mode for an analog current signal of +/-20 mA.

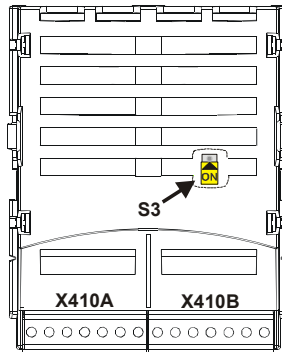

Operation mode – switch S3	Function
OFF - Voltage input	OFF (downward) – analog input EM-S1INA is configured for a voltage signal.
ON - Current input	ON (upward) – analog input EM-S1INA is configured for a current signal.

4.1.3 Characteristic

The mapping of the analog input signals onto a frequency or percentage reference value is possible for various demands. The parameterization is to be done via two points of the linear characteristic of the reference channel.

The characteristic point 1, with the coordinates X1 and Y1, and the characteristic point 2, with the coordinates X2 and Y2, can be set in four parameters.

The characteristic points X1 and X2 are stated as percentages, as the analog input can be switched as a current or voltage input via switch S3.

No.	Parameter Description	Setting		
		Min.	Max.	Fact. sett.
564	Characteristic point X1	-100.00 %	100.00 %	-98.00 %
565	Characteristic point Y1	-100.00 %	100.00 %	-100.00 %
566	Characteristic point X2	-100.00 %	100.00 %	98.00 %
567	Characteristic point Y2	-100.00 %	100.00 %	100.00 %

The coordinates of the characteristic points are related as a percentage to the analog signal, with 10 V or 20 mA, and the parameter *Maximum Frequency* **419** or parameter *Maximum reference percentage* **519**. The change of direction of rotation can be done via the digital inputs of the frequency inverter and/or by selecting the characteristic points.

The definition of the analog input characteristic can be calculated via the two-point form of the straight-line equation. The speed Y of the drive mechanism is controlled according to the analog control signal X.

$$Y = \frac{Y2 - Y1}{X2 - X1} \cdot (X - X1) + Y1$$

Attention! Monitoring of the analog input signal via the parameter *Error/Warning Behavior* **563** demands a check of the characteristic parameters. Sensible use is only possible if the *Characteristic point X1* **564** is in the positive range.

4.1.4 Operation modes

The operation modes of the analog input characteristic enable application-related scaling as a supplement to the characteristic points stated. One of the four linear types of characteristic is selected for adaptation of the signal for the analog input signal via the parameter *Operation mode* **562**.

If the characteristic points are not suited for the type of characteristic selected, the characteristic points are corrected internally.

Operation mode	Function
1 - bipolar	The analog input signal is mapped onto the reference figure according to the characteristic points (X1/Y1) and (X2/Y2).
11 - unipolar	With a negative parameter value of the characteristic points X1 or X2, they are mapped to the reference value zero.
21 - unipolar 2...10 V / 4...20 mA	If the characteristic points X1 or X2 have been set with a negative parameter figure or smaller than 0%, the input characteristic is mapped to the reference value 20%.
101 - bipolar absolute value	Negative parameter values of the characteristic points Y1 or Y2 are mapped as a positive reference value in the characteristic.

Further information on the operation modes stated in the table can be found in the following chapter "Examples".

4.1.4.1 Examples

The analog input signal is mapped onto a reference value as a function of the characteristic. The following examples show the operation modes for an analog voltage signal. The parameter *Minimum Frequency* **418** is set to the value 0.00 Hz. The characteristic point 100% for the Y-axis corresponds to the parameter *Maximum Frequency* **419** of 50.00 Hz in the examples.

Attention! The various operation modes change the input characteristic as a function of the parameterized characteristic points. In the following examples, the areas of the coordinate system from which a characteristic point is displaced are marked.

Operation mode "1 – bipolar"

In operation mode "1 – bipolar", the characteristic of the analog input can be freely set by stating two characteristic points.

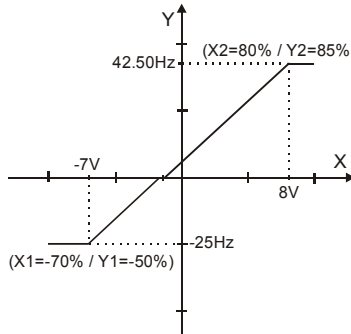

Characteristic point 1:

$$X1 = -70.00\% \cdot 10 \text{ V} = -7.00 \text{ V}$$

$$Y1 = -50.00\% \cdot 50.00 \text{ Hz} = -25.00 \text{ Hz}$$

Characteristic point 2:

$$X2 = 80.00\% \cdot 10 \text{ V} = 8.00 \text{ V}$$

$$Y2 = 85.00\% \cdot 50.00 \text{ Hz} = 42.50 \text{ Hz}$$

Tolerance band:

$$\Delta X = 2.00\% \cdot 10 \text{ V} = 0.20 \text{ V}$$

The change of direction of rotation is done in the example at an analog input signal of -1.44 V, with a tolerance band of ± 0.20 V.

Operation mode "11 – unipolar"

In operation mode "11 – unipolar", the characteristic points are displaced to the origin of the characteristics with a negative value for the X-axis.

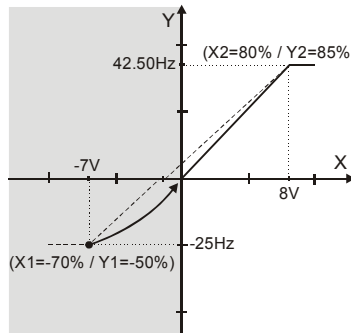

Characteristic point 1:

$$X1 = -70.00\% \cdot 10 \text{ V} = -7.00 \text{ V}$$

$$Y1 = -50.00\% \cdot 50.00 \text{ Hz} = -25.00 \text{ Hz}$$

Characteristic point 2:

$$X2 = 80.00\% \cdot 10 \text{ V} = 8.00 \text{ V}$$

$$Y2 = 85.00\% \cdot 50.00 \text{ Hz} = 42.50 \text{ Hz}$$

Tolerance band:

$$\Delta X = 2.00\% \cdot 10 \text{ V} = 0.20 \text{ V}$$

The characteristic point 1 has been displaced to the origin. The parameter *Tolerance band* **560** is not taken into account in this example, as no change of sign of the reference frequency value takes place.

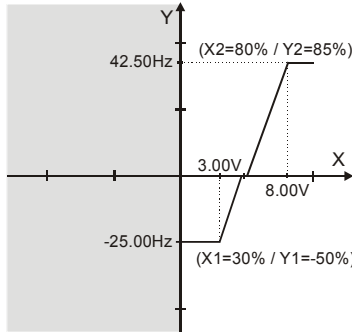

Characteristic point 1:

$$X1 = 30.00 \% \cdot 10 \text{ V} = 3.00 \text{ V}$$

$$Y1 = -50.00 \% \cdot 50.00 \text{ Hz} = -25.00 \text{ Hz}$$

Characteristic point 2:

$$X2 = 80.00 \% \cdot 10 \text{ V} = 8.00 \text{ V}$$

$$Y2 = 85.00 \% \cdot 50.00 \text{ Hz} = 42.50 \text{ Hz}$$

Tolerance band:

$$\Delta X = 2.00 \% \cdot 10 \text{ V} = 0.20 \text{ V}$$

The change of direction of rotation is done in the example at an analog input signal of 4.85 V, with a tolerance band of $\pm 0.20 \text{ V}$.

Operation mode "21 – unipolar 2...10 V / 4...20 mA"

This operation mode limits the input characteristic to the range between 20% and 100% of the analog signal. If the value for a characteristic point of the X-axis is outside 0%, it is mapped to the characteristic point (2 V / 0 Hz).

The characteristic point on the X-axis is calculated according to the following formula:

$$\text{characteristic point X} = \text{parameter value X} \cdot (100.00\% - 20.00\%) + 20.00\%$$

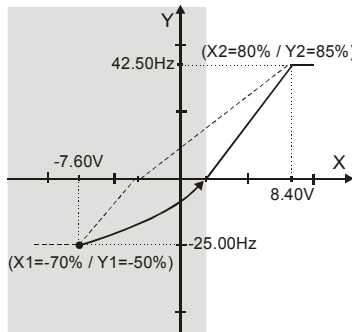

Characteristic point 1:

$$X1 = [-70.00\% \cdot (100.00\% - 20.00\%) + 20.00\%] \cdot 10 \text{ V} = -7.60 \text{ V}$$

$$Y1 = -50.00\% \cdot 50.00 \text{ Hz} = -25.00 \text{ Hz}$$

Characteristic point 2:

$$X2 = [80.00\% \cdot (100.00\% - 20.00\%) + 20.00\%] \cdot 10 \text{ V} = 8.40 \text{ V}$$

$$Y2 = 85.00\% \cdot 50.00 \text{ Hz} = 42.50 \text{ Hz}$$

Tolerance band:

$$\Delta X = [2.00\% \cdot (100.00\% - 20.00\%) \cdot 10 \text{ V}] = 0.16 \text{ V}$$

The characteristic point 1 has been displaced to the point (2.00 V / 0.00 Hz). The parameter *Tolerance band 560* is not used in this example, as no change of sign of the reference frequency value takes place.

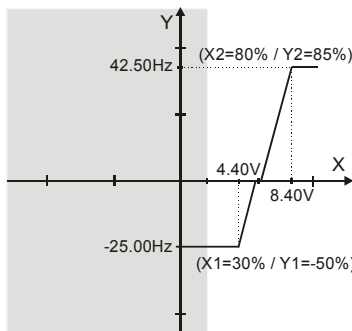

Characteristic point 1:

$$X1 = [30.00\% \cdot (100.00\% - 20.00\%) + 20.00\%] \cdot 10 \text{ V} = 4.40 \text{ V}$$

$$Y1 = -50.00\% \cdot 50.00 \text{ Hz} = -25.00 \text{ Hz}$$

Characteristic point 2:

$$X2 = [80.00\% \cdot (100.00\% - 20.00\%) + 20.00\%] \cdot 10 \text{ V} = 8.40 \text{ V}$$

$$Y2 = 85.00\% \cdot 50.00 \text{ Hz} = 42.50 \text{ Hz}$$

Tolerance band:

$$\Delta X = [2.00\% \cdot (100.00\% - 20.00\%) \cdot 10 \text{ V}] = 0.16 \text{ V}$$

The change of direction of rotation is done in the example at an analog input signal of 5.88 V, with a tolerance band of $\pm 0.16 \text{ V}$.

Operation mode "101 – bipolar absolute value"

The operation mode "101 – bipolar absolute value" maps the bipolar analog signal onto a unipolar input characteristic. The formation of the absolute amount takes the characteristic into account comparable to the "bipolar" operation mode, but the characteristic points are reflected on the X-axis with a negative value for the Y-axis.

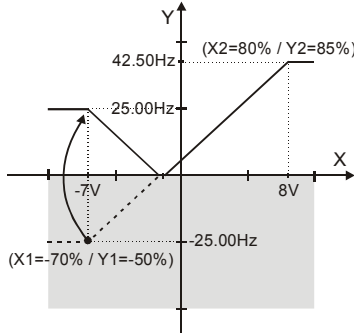

Characteristic point 1:

$X1 = -70.00\% \cdot 10 \text{ V} = -7.00 \text{ V}$
 $Y1 = -50.00\% \cdot 50.00 \text{ Hz} = -25.00 \text{ Hz}$

Characteristic point 2:

$X2 = 80.00\% \cdot 10 \text{ V} = 8.00 \text{ V}$
 $Y2 = 85.00\% \cdot 50.00 \text{ Hz} = 42.50 \text{ Hz}$

Tolerance band:

$\Delta X = 2.00\% \cdot 10 \text{ V} = 0.20 \text{ V}$

In this example, the reference value is again increased from an analog input signal of -1.44 V with a tolerance band of $\pm 0.20 \text{ V}$. The theoretical change of sign of the reference value is used and leads to the tolerance band stated.

There is no change of the direction of rotation.

4.1.5 Scaling

The analog input signal is mapped to the freely configurable characteristic. The maximum admissible setting range of the drive mechanism is to be set according to the configuration selected via the frequency limits or the percentage value limits. In the parameterization of a bipolar characteristic, the minimum and maximum limit for both directions of rotation are taken over. The percentage values of the characteristic points are relative to the maximum limits selected.

Parameter		Setting		
No.	Description	Min.	Max.	Fact. sett.
418	Minimum Frequency	0.00 Hz	999.99 Hz	3.50 Hz
419	Maximum Frequency	0.00 Hz	999.99 Hz	50.00 Hz

The controls use the maximum value of the output frequency, which is calculated from the *maximum frequency* **419** and the compensated slip of the drive mechanism. The frequency limits define the speed range of the drive mechanism and the reference percentage values supplement the scaling of the input characteristic according to the configured functions.

Parameter		Setting		
No.	Description	Min.	Max.	Fact. sett.
518	Minimum reference percentage	0.00 %	300.00 %	0.00 %
519	Maximum reference percentage	0.00 %	300.00 %	100.00 %

4.1.6 Tolerance band and hysteresis

The analog input characteristic with change of sign of the reference value can be adapted by the parameter *Tolerance band* **560** of the application. The tolerance band to be defined extends the zero crossing of the speed relative to the analog control signal. The percentage parameter value is relative to the maximum current or voltage signal.

Parameter		Setting		
No.	Description	Min.	Max.	Fact. sett.
560	Tolerance band	0.00 %	25.00 %	2.00 %

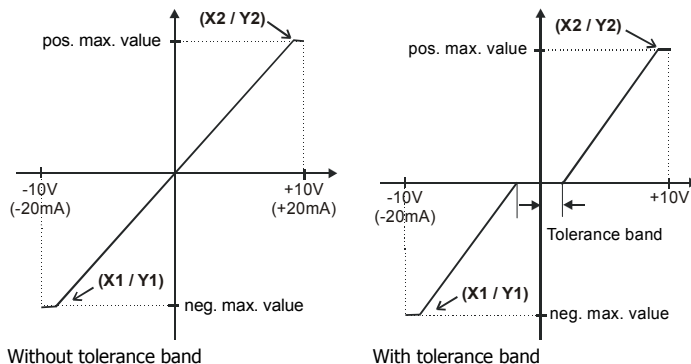

The *Minimum Frequency* **418** or the *Minimum reference percentage* **518** set in the factory extends the parameterized tolerance band to the hysteresis.

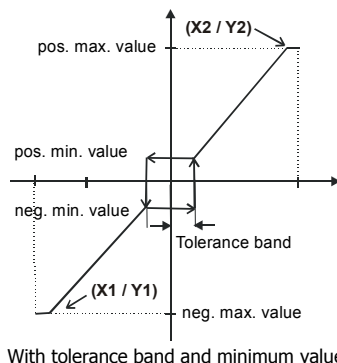

For example, the output variable resulting from the positive input signals is kept at the positive minimum value until the input signal is below the value for the tolerance band in a negative direction. After that proceed on the set characteristic.

4.1.7 Error and warning behavior

The monitoring of the analog input signal necessary according to the application is to be configured via the parameter *Error/Warning behavior* **563**.

Operation mode	Function
0 - Off	The input signal is not monitored.
1 - Warning < 1 V / 2 mA	If the input signal is less than 1 V or 2 mA, there is a warning message.
2 - Shutdown < 1 V / 2 mA	If the input signal is less than 1 V or 2 mA, there is a warning message, the drive mechanism is decelerated according to stopping behavior 1.
3 - Fault switch-off < 1 V / 2 mA	If the input signal is less than 1 V or 2 mA, there is a warning and fault message and the drive mechanism stops freely.

The monitoring of the analog input signal is active independent of the release of the frequency inverter according to the operation mode selected.

In operation mode **2**, the drive mechanism is decelerated independent of the stopping behavior set (Parameter *Operation mode* **630**) according to stopping behavior 1 (shutdown and switch-off). If the set holding time has expired, there is a fault message. A repeat start of the drive mechanism is possible by switching the start signal on and off if the fault has been cleared.

Operation mode **3** defines the free stoppage of the drive mechanism, independent of the stopping behavior selected, which is stipulated with the parameter *Stop function* **630**.

Attention! Monitoring of the analog input signal via the parameter *Error/Warning Behavior* **563** demands a check of the characteristic parameters.

4.1.8 Adjustment

As a result of component tolerances, it can be necessary to adjust the analog input. Parameter *Adjustment 568* is used for this purpose.

Operation mode	Function
0 - no adjustment	Normal operation
1 - Adjustment 0 V / 0 mA	Adjustment of the measurement with an analog signal of 0 V or 0 mA.
2 - Adjustment 10 V / 20 mA	Adjustment of the measurement with an analog signal of 10 V or 20 mA.

Example of the adjustment of the analog input with a voltage signal:

Note: The measurements for the adjustment are to be done with a suitable measuring instrument and the correct polarity. If not, faulty measurements can result.

- Apply 0 V to the analog input; e.g. with a wired link from the socket of the analog input X410B.4 to socket X210B.7 (earth/GND) of the frequency inverter.
- Select operation mode "1 - Adjustment 0 V / 0 mA".
- Apply 10 V to the analog input, e.g. with a wired link from the socket of the analog input to socket X210B.5 (reference output 10 V) of the frequency inverter.
- Select operation mode "2 - Adjustment 10 V / 20 mA".

4.1.9 Filter time constant

The time constant of the filter for the reference analog value can be set via the parameter *Filter time constant 561*.

The time constant states the time for which the input signal is averaged by means of a low pass filter, e.g. in order to eliminate fault effects.

The setting range is a range of values between 0 ms and 5000 ms in 15 steps.

Operation mode	Function
0 - Time constant 0 ms	Filter deactivated – analog reference value is forwarded unfiltered
2 - Time constant 2 ms	Filter activated – averaging of the input signal via the set value of the filter time constants
4 - Time constant 4 ms	
8 - Time constant 8 ms	
16 - Time constant 16 ms	
32 - Time constant 32 ms	
64 - Time constant 64 ms	
128 - Time constant 128 ms	
256 - Time constant 256 ms	
512 - Time constant 512 ms	
1000 - Time constant 1000 ms	
2000 - Time constant 2000 ms	
3000 - Time constant 3000 ms	
4000 - Time constant 4000 ms	
5000 - Time constant 5000 ms	

4.2 Resolver input EM-RES

The resolver input is used for evaluating the position information from the resolver.

The frequency of the field signal for the resolver can be selected via parameter *Operation Mode* **380**.

Operation mode		Function
5- frequency 5 kHz		Frequency of the reference signal for the resolver
10- frequency 10 kHz		
20- frequency 20 kHz		

If the no. of resolver pole pairs > 1, the measured electric angle runs through the range of 0°...360° several times during one mechanical revolution.

For the detection of the position angle of the rotor at a synchronous motor, the ratio of the no. of motor pole pairs to the no. of resolver pole pairs must be an integer.

The no. of pole pairs of the resolver can be adjusted via parameter *No. of Pole Pairs* **381**.

Parameter		Function		
No.	Description	Min.	Max.	Fact. sett.
381	No. of pole pairs	1	24	1

Assignment of the socket:

Resolver field signal EM-RES (X410A.1): REF+

Resolver field signal EM-RES (X410A.2): REF-

Resolver input EM-RES (X410A.3): SIN-

Resolver input EM-RES (X410A.4): SIN+

Resolver input EM-RES (X410A.5): COS-

Resolver input EM-RES (X410A.6): COS+

4.2.1 Offset

In order to enable the start of a synchronous machine, the absolute position of the rotor must be known. This information is required in order to actuate the stator windings in the right order depending on the position of the rotor. The position of the rotary field in the synchronous machine must be controlled in order to obtain a continuous movement of the rotor. During first commissioning, the position of the rotor winding of the resolver is adjusted to the rotor displacement angle of the synchronous motor by adjusting the offset. For operating a synchronous machine with resolver, the offset must be adjusted in order to obtain perfectly true running and a maximum torque.

The correct *Offset* **382** is adjusted when the *flux-forming voltage* **235** reaches the value 0 (approximately) while the motor is turning.

Parameter		Function		
No.	Description	Min.	Max.	Fact. sett.
382	Offset	-360.0°	360.0°	0.0°

The offset can be determined and adjusted as follows:

- During first commissioning "SETUP" will be displayed in the control unit. Press ESC to stop this operation. The guided commissioning („SETUP") is performed after adjusting the offset.
- Open the parameter menu "PARA" and enter the machine data indicated on the type plate or the data sheet of the motor.

- Set parameter *Operation Mode* **380** to the frequency value of the field signal for the resolver.
- Adjust parameter *No. of Pole Pairs* **381** to the number of pole pairs of the resolver.

Before adjusting the offset, take the following **safety precautions**:

- Disable the frequency inverter via digital input S1IND (controller release).
- If possible, uncouple the motor from the load so that the motor shaft turns freely. If installed, release the mechanical brake.
If uncoupling is not possible, make sure that the motor is loaded as little as possible.



Warning! In certain circumstances, the motor speed may reach high values. If the motor is not uncoupled from the load, personal and material damage may result. To avoid such damage, make the following settings in any case.

- Set the max. permissible output frequency of the frequency inverter to a low frequency value via parameter *Switch-Off Limit* **417**. Select the frequency value such that uncontrolled acceleration of the motor ("overspeeding") is detected at an early stage. This limitation is necessary in order to avoid personal and material damage.
- Set parameter *Current Limit* **728** of the speed controller to a low current value (e.g. 10% of the rated motor current). In this way it is made sure that there are no excessive currents of the offset is set incorrectly.
- Turn motor shaft manually. Check the sense of rotation of the resolver via the actual value of parameter *Frequency Speed Sensor 2* **219**. In the case of a clock-wise rotation of the motor shaft, positive values are displayed for the actual frequency value. If the displayed sense of rotation does not correspond to the actual sense of rotation, change the connections SIN+ and SIN- at socket X410A of the frequency inverter.

The *Offset* **382** must be between 0° and 360°, divided by the number of motor pole pairs. If the number of resolver pole pairs is higher than 1, the possible range is between 0° and the max. offset.

$$\text{Max. Offset} = \frac{360^\circ}{\text{number of motor pole pairs} / \text{number of resolver pole pairs}}$$

If the adjusted value is changed by the max. offset, this does not affect the *flux-forming voltage* **235**.

- Adjust a low reference speed value (approx. 10% lower than the *Switch-off Limit Frequency* **417**), and enable the frequency inverter via digital input S1IND (controller release) and S2IND (start clock-wise operation) in order to accelerate the motor.
- If an overcurrent is detected or a fault message is issued due to an overload, the guided commissioning (setup) will start first. Confirm the machine and resolver data. After completion of the guided commissioning, adjust the parameter *Limit Current* **728** to a low value again because this value was overwritten during the guided commissioning.

Depending on the behavior of the motor after start, carry out the following steps:

- **Motor does not turn, or the motor shaft only turns to a new position and stops again:**
 - Check if the parameters *No. of Pole Pairs* **373** for the motor and *No. of Pole Pairs* **381** for the resolver are set correctly.

If these values are adjusted correctly, take the following measures complying with the safety instructions.



Warning! The mains, direct voltage and motor sockets can be live with dangerous voltage after disconnection of the frequency inverter. Work only on the device after a waiting period of some minutes until the DC link capacitors have discharged.

- Before electrical installation work, de-energize the frequency inverter and take appropriate precautions to make sure it is not re-energized unintentionally. Make sure that the frequency inverter is de-energized.
- Exchange two motor phases (e.g. U and V) at the frequency inverter sockets because the senses of rotation of the motor and the resolver do not correspond to each other.
- Switch on the power supply again.
- As described above, adjust a low speed reference value and start the motor.

If the motor does not start despite the phase exchange:

- Increase the parameter value for *Offset* **382** by 90°, divided by the no. of motor pole pairs.

If the motor still does not turn, exchange the two motor phases (e.g. U and V) again.

- **The motor turns and accelerates until it reaches the *Frequency Switch-Off Limit* **417**:**
 - Check the resolver lines and check the resolver connection contacts.
 - In the case of fault message "Overfrequency" F1100: increase the parameter value for *Offset* **382** by 180°, divided by the no. of motor pole pairs.
- **If the motor turns at the adjusted speed and in the right direction, carry out the fine adjustment of the offset:**
 - Adjust the parameter value for *Offset* **382** in small steps (e.g. 2.5°) until the *flux-forming voltage* **235** is approximately 0.
 - In case the flux-forming voltage deviates from 0 significantly, adjust the offset in bigger steps.
 - In the case of a positive flux-forming voltage, increase the offset.
 - In the case of a negative flux-forming voltage, reduce the offset.
 - Adjust parameters *Frequency Switch-Off Limit* **417** and *Current Limit* **728** to the required values.
 - Repeat the **fine adjustment** of the offset at 50% of the rated frequency.

This completes the offset adjustment.

- Start the guided commissioning. This is required for optimum current control.

4.2.2 Actual speed source

Switch-over is effected via *Actual Speed Source 766*. If the resolver delivers the actual value signal for the speed controller, speed sensor 2 must be selected as the source. In the basic setting, speed sensor 1 is used as the actual value source.

Operation mode	Function
1 - Speed sensor 1	The actual speed source is speed sensor 1 of the basic device (factory setting).
2 - Speed sensor 2	The actual speed source is speed sensor 2 of the EM-RES-02 expansion module.

4.3 Frequency and percentage reference channel

The varied functions for the specification of the reference values are connected in the various configurations by the frequency or percentage reference channel. The *Reference frequency source 475*, and the *Reference percentage source 476* determine the additive connection of the available reference sources as a function of the installed hardware.

Operation mode	Function
2 - EM-S1INA, absolute value	Reference source is the analog input EM-S1INA
4 - MFI1A + EM-S1INA, absolute value	Reference sources are the multifunctional input MFI1A and the analog input EM-S1INA
14 - MFI1A + EM-S1INA + FF, absolute value	Reference sources are the multifunctional input MFI1A, analog input EM-S1INA and fixed frequency FF
24 - MFI1A + EM-S1INA + MP, absolute value	Reference sources are the multifunctional input MFI1A, analog input EM-S1INA and the motor potentiometer function MP
34 - speed sensor 2 (F2), absolute value	The frequency signals of the resolver are evaluated using a fixed number of division marks of 1024 as a reference value.
102 to 124	Operation modes with signs (+/-)

Additional to the operation modes listed, those stated in the operating instructions of the frequency inverter in the chapter "Frequency reference channel", and in the chapter "Percentage reference channel" also apply.

4.4 Actual value display

The actual value of speed sensor 2 can be read via the parameters *Frequency speed sensor 2* **219** and *Speed, speed sensor 2* **220**.

The analog input signal on analog input EM-S1INA can be a voltage or a current signal depending on the setting of switch **S3**. Accordingly, the actual value parameter *Analog input EM-S1INA* **253** is displayed as a percentage.

4.5 Repetition frequency output EM-RFOUT

The repetition frequency output EM-RFOUT emulates a speed sensor. The repetition frequency output delivers the frequency signal of the resolver as a simulation of an incremental speed sensor with reference signal. The number of division marks is set permanently to 1024 division marks, thus no parameterization is required.

Assignment of the outputs:

Repetition frequency output EM-RFOUT (X410A.7): track A+
Repetition frequency output EM-RFOUT (X410B.1): track A-
Repetition frequency output EM-RFOUT (X410B.2): track B+
Repetition frequency output EM-RFOUT (X410B.3): track B-
Repetition frequency output EM-RFOUT (X410A.5): reference signal R+
Repetition frequency output EM-RFOUT (X410A.6): reference signal R-

5 Parameter list

The parameter list is structured according to the menu branches of the control unit. For better clarity, the parameters are marked with pictograms:

-  The parameter is available in the four data sets
- The parameter value is adjusted by the SETUP routine if a control method for a synchronous machine is selected for parameter *Configuration 30*.
- This parameter cannot be written in the operation of the frequency inverter

5.1 Actual value menu (VAL)

Actual values of the machine				
No.	Description	Unit	Display range	Chapter
219	Frequency speed sensor 2	Hz	0.0 ... 999.99	4.4
220	Speed, speed sensor 2	rpm	0 ... 60000	4.4
Actual values of the frequency inverter				
253	Analog input EM-S1INA	%	-100 ... +100	4.4

5.2 Parameter menu (PARA)

Resolver					
No.	Description	Unit	Setting range	Chapter	
<input checked="" type="checkbox"/> <input checked="" type="checkbox"/>	380	Operation mode	-	Selection	4.2
<input checked="" type="checkbox"/>	381	No. of pole pairs	-	1 ... 24	4.2
<input checked="" type="checkbox"/>	382	Offset	-	-360.0 ... 360.0	4.2.1
Analog input					
<input checked="" type="checkbox"/>	560	Tolerance band	%	0.00 ... 25.00	4.1.6
	561	Filter time constant	-	Selection	4.1.9
	562	Operation mode	-	Selection	4.1.4
	563	Error/warning behavior	-	Selection	4.1.7
<input checked="" type="checkbox"/>	564	Characteristic point X1	%	-100.00 ... 100.00	4.1.3
<input checked="" type="checkbox"/>	565	Characteristic point Y1	%	-100.00 ... 100.00	4.1.3
<input checked="" type="checkbox"/>	566	Characteristic point X2	%	-100.00 ... 100.00	4.1.3
<input checked="" type="checkbox"/>	567	Characteristic point Y2	%	-100.00 ... 100.00	4.1.3
	568	Adjustment	-	Selection	4.1.8
Speed controller					
<input checked="" type="checkbox"/>	766	Actual speed source	-	Selection	4.2.2

6 Annex

6.1 Error messages

The various control functions and methods and the hardware of the frequency inverter contain functions which continuously monitor the application. As a supplement to the messages documented in these operating instructions, the following failure keys are activated by the EM-RES-02 expansion module.

Control connections		
F14	21	Resolver synchronization not successful. Check resolver signal for interferences.
	22	Resolver counting error: Check resolver signal for interferences.
	23	Resolver pole pair number is invalid. The ratio of the no. of pole pairs to the no. of resolver pole pairs must be an integer number. Check parameters <i>No. of Pole Pairs</i> 373 for the motor and und <i>No. of Pole Pairs</i> 381 for the resolver, correct if necessary.
	24	Open circuit: check resolver connections and lines.

Additional to the listed fault messages, there are further fault messages for internal purposes and not listed here. If you receive fault messages, which are not listed here, please contact us by phone.



Bonfiglioli has been designing and developing innovative and reliable power transmission and control solutions for industry, mobile machinery and renewable energy applications since 1956.

www.bonfiglioli.com