



Bonfiglioli

Vectron

ACTIVE and ACTIVE Cube

Expansion Module EM-ENC-04
Frequency Inverter 230V / 400V



General points on the documentation

The present supplement of the documentation is valid for the frequency inverter series ACT and ACU. The information necessary for the assembly and application of the EM-ENC-04 expansion module is documented in this guidance.

For better clarity, the user documentation is structured according to the customer-specific demands made of the frequency inverter.

Brief instructions

The brief instructions describe the fundamental steps for mechanical and electrical installation of the frequency inverter. The guided commissioning supports you in the selection of necessary parameters and the software configuration of the frequency inverter.

Operating instructions

The operating instructions document the complete functionality of the frequency inverter. The parameters necessary for specific applications for adaptation to the application and the extensive additional functions are described in detail.

Application manual

The application manual supplements the documentation for purposeful installation and commissioning of the frequency inverter. Information on various subjects connected with the use of the frequency inverter is described specific to the application.

Installation instructions

As a complement of the brief instructions and the operating instructions, the installation instructions describe the installation and use of devices.

The documentation and additional information can be requested via your local representation of the company BONFIGLIOLI.

The following pictograms and signal words are used in the documentation:



Danger!

means a directly threatening danger. Death, serious damage to persons and considerable damage to property will occur if the precautionary measure is not taken.



Warning!

marks a possible threat. Death, serious damage to persons and considerable damage to property can be the consequence if attention is not paid to the text.



Caution!

refers to an indirect threat. Damage to people or property can be the result.

Attention!

refers to a possible operational behavior or an undesired condition, which can occur in accordance with the reference text.

Note

marks information, which facilitates handling for you and supplements the corresponding part of the documentation.



Warning! In installation and commissioning, comply with the information in the documentation. You as a qualified person must read the documentation carefully before the start of the activity and obey the safety instructions. For the purposes of the instructions, "qualified person" designates a person acquainted with the erection, assembly, commissioning and operation of the frequency inverters and possessing the qualification corresponding to the activity.

TABLE OF CONTENTS

1	General safety and application information	4
1.1	General information.....	4
1.2	Proper use.....	4
1.3	Transport and storage	5
1.4	Handling and positioning.....	5
1.5	Electrical connection.....	5
1.6	Operation information	5
1.7	Maintenance and service	5
2	Introduction	6
3	Installation of the EM-ENC-04 expansion module.....	7
3.1	General	7
3.2	Mechanical installation.....	7
3.3	Electrical installation	9
3.3.1	Circuit diagram	9
3.3.2	Control sockets.....	10
4	Control inputs and outputs	11
4.1	Analog input EM-S1INA	11
4.1.1	General.....	11
4.1.2	Configuration voltage/current input	11
4.1.3	Characteristic	12
4.1.4	Operation modes	12
4.1.4.1	Examples.....	13
4.1.5	Scaling.....	15
4.1.6	Tolerance band and hysteresis.....	16
4.1.7	Error and warning behavior	17
4.1.8	Adjustment	18
4.1.9	Filter time constant.....	18
4.2	Analog output EM- S1OUTA	19
4.2.1	General.....	19
4.2.2	Operation modes	19
4.2.3	Adjustment	19
4.2.4	Zero adjustment and amplification	20
4.2.4.1	Examples.....	20
4.3	Digital output EM-S1OUTD	21
4.3.1	General.....	21
4.3.2	Operation modes	21
4.4	Speed sensor input EM-ENC	21
4.4.1	Termination resistor	22
4.4.2	Division marks speed sensor 2	23
4.4.3	Level	23
4.4.4	Actual speed source.....	23
4.4.5	Actual value comparison.....	24
4.5	Frequency and percentage reference channel	24
4.6	Actual value display.....	25

TABLE OF CONTENTS

5	Parameter list	26
5.1	Actual value menu (VAL)	26
5.2	Parameter menu (PARA)	26
6	Annex	27
6.1	Error messages	27

1 General safety and application information

This documentation has been created with greatest care and has been extensively and repeatedly checked. For reasons of clarity, we have not been able to take all detailed information on all the types of the products and also not every imaginable case of positioning, operation or maintenance into account. If you require further information or if particular problems not treated extensively enough in the operating instructions occur, you can obtain the necessary information via the local representation of the company BONFIGLIOLI.

In addition, we would point out that the contents of these operating instructions are not part of an earlier or existing agreement, assurance or legal relationship, nor are they intended to amend them. All the manufacturer's obligations result from the purchase contract in question, which also contains the completely and solely valid warranty regulation. These contractual warranty provisions are neither extended nor limited by the implementation of these operating instructions.

The manufacturer reserves the right to correct or amend the contents and product information as well as omissions without specific announcement and assumes no kind of liability for damage, injuries or expenditure to be put down to the aforementioned reasons.

1.1 General information



Warning! BONFIGLIOLI VECTRON frequency inverters have high voltage levels during operating, depending on their protection class, drive moving parts and have hot surfaces.

In the event of inadmissible removal of the necessary covers, improper use, wrong installation or operation, there is the risk of serious damage to persons or property.

To avoid the damage, only qualified staff may carry out the transport, installation, setup or maintenance work required. Comply with the s EN 50178, IEC 60364 (Cenelec HD 384 or DIN VDE 0100), IEC 60664-1 (Cenelec HD 625 or VDE 0110-1), BGV A2 (VBG 4) and national provisions. Qualified persons within the meaning of this principal safety information are people acquainted with the erection, fitting, commissioning and operating of frequency inverters and the possible hazards and in possession of qualifications matching their activities.

1.2 Proper use



Warning! The frequency inverters are electrical drive components intended for installation in industrial plant or machines. Commissioning and start of intended operation are not allowed until it has been established that the machine corresponds to the provisions of the EC machine directive 98/37/EEC and EN 60204. According to the CE sign, the frequency inverters additionally fulfill the requirements of the low-voltage directive 73/23/EEC and the s EN 50178 / DIN VDE 0160 and EN 61800-2. Responsibility for compliance with the EMC directive 89/336/EEC is with the user. Frequency inverters are available in a limited way and as components exclusively intended for professional use within the meaning of the EN 61000-3-2.

With the issue of the UL according to UL508c, the requirements of the CSA Standard C22.2-No. 14-95 have also been fulfilled.

The technical data and the information on connection and ambient conditions the rating plate and the documentation be complied with. The instructions must have been read and understood before starting work at the device.

1.3 Transport and storage

Transport and storage are to be done appropriate in the original packing. Store the units only in dry rooms, which are protected against dust and moisture and are subjected to little temperature deviations only. Observe the climatic conditions according to standard EN 50178 and to the information on the label of the original packing. The duration of storage without connection to the admissible reference voltage may not exceed one year.

1.4 Handling and positioning



Warning! Damaged or destroyed components may not be put into operation because they may be a health hazard.

The frequency inverters are to be used according to the documentation, the directives and the standards. Handle carefully and avoid mechanical overload. Do not bend the components or change the isolation distances. Do not touch electronic components or contacts. The devices contain construction elements with a risk of electrostatic, which can easily be damaged by improper handling. Any use of damaged or destroyed components shall be considered as a non-compliance with the applicable standards. Do not remove any warning signs from the device.

1.5 Electrical connection



Warning! Before any assembly or connection work, de-energize the frequency inverter. Make sure that the frequency inverter is de-energized. Do not touch the sockets, because the capacitors may still be charged. Comply with the information given in the operating instructions and on the frequency inverter label.

While working on the frequency inverters, obey the applicable standards BGV A2 (VGB 4), VDE 0100 and other national directives. Comply with the information in the documentation on electrical installation and the relevant directives. Responsibility for compliance with and examination of the limit values of the EMC product standard EN 61800-3 for variable-speed electrical drive mechanisms is with the manufacturer of the industrial plant or machine.

The documentation contains information on installation correct for EMC. The cables connected to the frequency inverters may not be subjected to an isolation test with a high test voltage without previous circuit measures.

1.6 Operation information



Warning! Before commissioning and the start of the intended operation, attach all the covers and check the sockets. Check additional monitoring and protective devices pursuant to EN 60204 and the safety directives applicable in each case (e.g. Working Machines Act, Accident Prevention Directives etc.). No connection work may be performed, while the system is in operation.

1.7 Maintenance and service



Warning! Unauthorized opening and improper interventions can lead to physical injury or damage to property. Repairs on the frequency inverters may only be done by the manufacturer or persons authorized by the latter.

2 Introduction

This document describes the possibilities and the properties of the EM-ENC-04 expansion module for the frequency inverters of the ACT and ACU device series.

Note: This document exclusively describes the EM-ENC-04 expansion module. It does not provide basic information on the operation of the ACT and ACU series frequency inverters.

The EM-ENC-04 expansion module is an optional hardware component to extend the functionality of the frequency inverter. It enables the data exchange within the network between the components which have been directly connected, for example control and regulation elements.

The EM-ENC-04 module extends the functionality of the frequency inverters of the ACT and ACU device series by the following additional functions:

- **Analog input**
(second bipolar analog input)
- **Analog output**
(second bipolar analog output)
- **Relay output**
(Normally open contacts)
- **Speed sensor input**
(second incremental speed sensor input)

The EM-ENC-04 expansion module has been enclosed with the frequency inverter as a separate component and must be fitted by the user. This is described in detail in the chapter "Mechanical Installation".

To assemble the expansion module it can be simply plugged into the frequency inverters of the ACT and ACU device series.



Warning! The assembly is done before the frequency inverter is put into operation, and only in a voltage-free state.

The pluggable sockets of the expansion module enable economical overall fitting with a safe function.

3 Installation of the EM-ENC-04 expansion module

3.1 General

The mechanical and electrical installation of the EM-ENC-04 expansion module is to be carried out by qualified personnel according to the general and regional safety and installation directives. Safe operation of the frequency inverter requires that the documentation and the device specification be complied with during installation and start of operation. For specific areas of application further provisions and guidelines must be complied with where applicable.

The frequency inverters are designed according to the requirements and limit values of product standard EN 61800-3 with an interference immunity factor (EMI) for operation in industrial applications. The electromagnetic interference is to be avoided by expert installation and observation of the specific product information.

For further information, refer to the chapter "Electrical Installation" of the frequency inverter operating instructions.



Danger! All connection sockets where dangerous voltage levels may be present (e.g. motor connection sockets, mains sockets, fuse connection sockets, etc.) must be protected against direct contact.

3.2 Mechanical installation



Danger! If the following instructions are not complied with, there is direct danger with possible consequences of death or severe injury by electrical current. To disregard the instructions can lead to destruction of the frequency inverter and/or of the expansion module.

- Before assembly or disassembly of the EM-ENC-04 expansion module, the frequency inverter must be de-energized. Take appropriate measures to make sure it is not energized unintentionally.
- Make sure that the frequency inverter is de-energized.



Danger! The mains, direct voltage and motor sockets can be live with dangerous voltages after disconnection of the frequency inverter. Work may only be done on the device after a waiting period of some minutes until the DC link capacitors have been discharged.

The EM-ENC-04 expansion module is supplied in a housing for assembly on the lower slot of the frequency inverter.

- Remove the lower cover (1) of the frequency inverter.
The slot for the EM-ENC-04 expansion module becomes accessible.

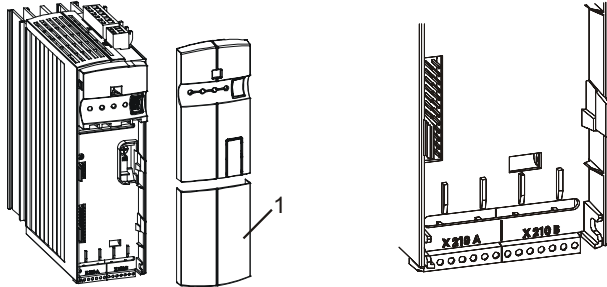

Caution: The EM-ENC-04 expansion module (2) is pre-fitted in a housing. Do NOT touch the PCB visible on the back, as modules may be damaged.

- Plug the EM-ENC-04 expansion module (2) onto the slot (3).

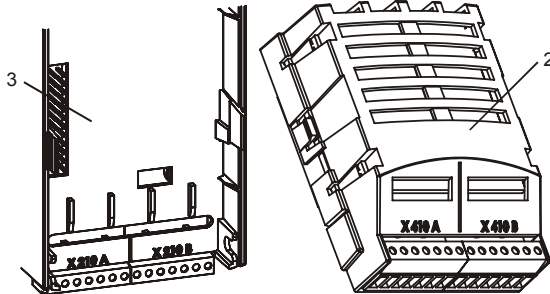

- Re-install the lower cover (1).

This completes the assembly procedure.

When the supply voltage of the frequency inverter is switched on, the EM-ENC-04 expansion module is ready for operation.

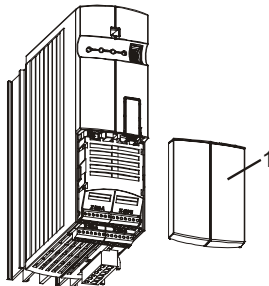

3.3 Electrical installation



Danger! If the following instructions are not complied with, there is direct danger with the possible consequences of death or severe injury by electrical current. Further, failure to comply can lead to destruction of the frequency inverter and/or of the expansion module.

- Before assembly or disassembly of the EM-ENC-04 expansion module, the frequency inverter must be de-energized. Take appropriate measures to make sure it is not energized unintentionally.
- Make sure that the frequency inverter is de-energized.



Danger! The mains, direct voltage and motor sockets can have dangerous voltages even after disconnection of the frequency inverter. Work may only be done on the device after a waiting period of some minutes until the DC link capacitors have been discharged.

3.3.1 Circuit diagram

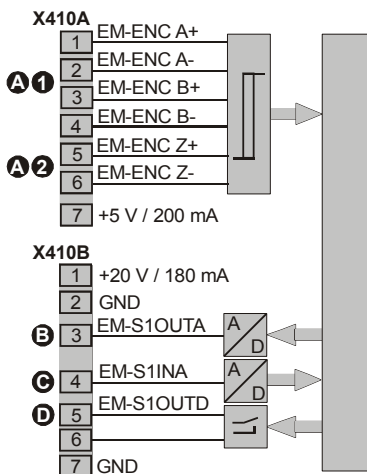

A Speed sensor input EM-ENC

- A 1** Frequency signal, $f_{\max} = 300 \text{ kHz}$, voltage-proof until 30 V, TTL (push-pull) according to specification RS-422A / RS-485: $U_{\max} = 5 \text{ V}$, HTL (push-pull or unipolar): $I_{\max} = 12 \text{ mA}$ at 24 V
- A 2** Reference signal

B Analog output EM- S1OUTA

Analog signal, $U_{\max} = \pm 10 \text{ V}$, $I_{\max} = 2 \text{ mA}$, overload and short-circuit proof

C Analog input EM-S1INA

Analog signal, resolution 12 Bit, $U_{\max} = \pm 10 \text{ V}$ ($R_i = 100 \text{ k}\Omega$), $I_{\max} = \pm 20 \text{ mA}$ ($R_i = 250 \Omega$)

D Relay connection EM-S1OUTD

make contact, response time approx. 40 ms, 24 V AC / 1 A, 24 V DC / 1 A (ohmic)

3.3.2 Control sockets

The control and software functionality can be freely configured for economical operation with a safe function.

Expansion module EM-ENC-04

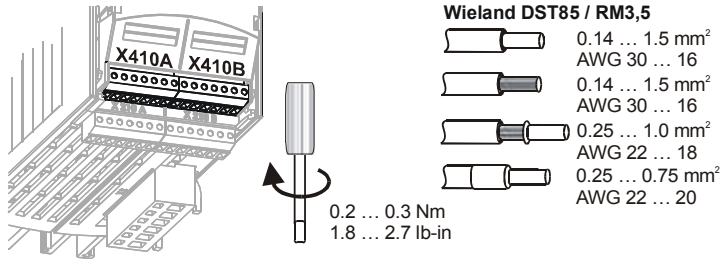

Caution! The control inputs and outputs must be connected and disconnected free of electrical power. Otherwise components may be damaged.

Socket X410A

Ter.	Description
1	Speed sensor input EM-ENC A+
2	Speed sensor input EM-ENC A-
3	Speed sensor input EM-ENC B+
4	Speed sensor input EM-ENC B-
5	Speed sensor input EM-ENC Z+
6	Speed sensor input EM-ENC Z-
7	Voltage output 5 V, $I_{\max} = 200 \text{ mA}$ ¹⁾

Socket X410B

Ter.	Description
1	Voltage output 20 V, $I_{\max} = 180 \text{ mA}$ ¹⁾
2	Earth / GND
3	Analog output EM-S1OUTA, $U_{\max} = \pm 10 \text{ V}$, $I_{\max} = 2 \text{ mA}$
4	Analog input EM-S1INA, resolution 12 bit, $U_{\max} = \pm 10 \text{ V}$ ($R_i = 100 \text{ k}\Omega$), $I_{\max} = \pm 20 \text{ mA}$ ($R_i = 250 \Omega$)
5	Digital output EM-S1OUTD, Normally open contact, $U_{\max} = 24 \text{ V AC/DC}$, 1 A
6	(ohm)
7	Earth / GND

¹⁾ The power supplies at sockets X410A.7 and X410B.1 may be loaded with a maximum current of $I_{\max} = 200 \text{ mA}$ and $I_{\max} = 180 \text{ mA}$. Relative to the application, the maximum current available will be reduced by the further control outputs in the basic device and the expansion module.

4 Control inputs and outputs

4.1 Analog input EM-S1INA

4.1.1 General

The analog input of the EM-ENC-04 expansion module can optionally be configured as a voltage or a current input. Parameterization of the input signal is done by the definition of a linear characteristic and assignment as a

- reference value source
(can be selected via the parameter *Reference frequency source 475*),
- reference percentage source
(can be selected via the parameter *Reference percentage source 476*),
- actual percentage source
(can be selected via the parameter *Actual percentage source 478*, in configuration **x11**) or
- limit value source
(can be selected via the parameter *Limit Source 734...737*).

4.1.2 Configuration voltage/current input

The analog input of the EM-ENC-04 expansion module has been configured in the factory setting for a voltage signal of +/- 10 V.

Switch **S1** enables a switchover of the operation mode for an analog current signal of +/- 20 mA.

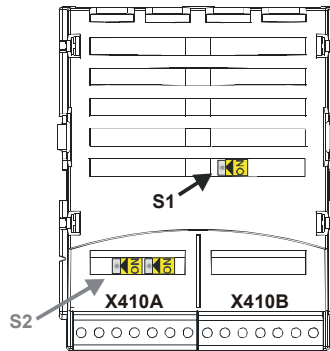

Operation mode – switch S1	Function
OFF -Voltage input	OFF (to the right) – analog input EM-S1INA is configured for a voltage signal.
ON -Current input	ON (to the left) – analog input EM-S1INA is configured for a current signal.

Note: The switches **S2** activate the termination resistor of 150 Ω for the speed sensor input according to specification RS422-A / RS-485 (described in Chapter "Speed Sensor Input EM-ENC).

4.1.3 Characteristic

The mapping of the analog input signals onto a frequency or percentage reference value is possible for various demands. The parameterization is to be done via two points of the linear characteristic of the reference channel.

The characteristic point 1, with the coordinates X1 and Y1, and the characteristic point 2, with the coordinates X2 and Y2, are to be set in the four data sets.

The characteristic points X1 and X2 are stated as percentages, as the analog input can be switched as a current or voltage input via switch S1.

Parameter		Setting		
No.	Description	Min.	Max.	Fact. sett.
564	Characteristic point X1	-100.00 %	100.00 %	-98.00 %
565	Characteristic point Y1	-100.00 %	100.00 %	-100.00 %
566	Characteristic point X2	-100.00 %	100.00 %	98.00 %
567	Characteristic point Y2	-100.00 %	100.00 %	100.00 %

The coordinates of the characteristic points are related as a percentage to the analog signal, with 10 V or 20 mA, and the parameter *Maximum Frequency* **419** or parameter *Maximum reference percentage* **519**. The change of direction of rotation can be done via the digital inputs and/or by selecting the characteristic points.

The definition of the analog input characteristic can be calculated via the two-point form of the straight-line equation. The speed Y of the drive mechanism is controlled according to the analog control signal X.

$$Y = \frac{Y2 - Y1}{X2 - X1} \cdot (X - X1) + Y1$$

Attention! Monitoring of the analog input signal via the parameter *Error/Warning Behavior* **563** demands a check of the characteristic parameters. Sensible use is only possible if the *Characteristic point X1* **564** is in the positive range.

4.1.4 Operation modes

The operation modes of the analog input characteristic enable application-related scaling as a supplement to the characteristic points stated. One of the four linear types of characteristic is selected for adaptation of the signal for the analog input signal via the parameter *Operation mode* **562**. If the characteristic points are not suited for the type of characteristic selected, the characteristic points are corrected.

Operation mode	Function
1 -bipolar	The analog input signal is mapped onto the reference figure according to the characteristic points (X1/Y1) and (X2/Y2).
11 -unipolar	With a negative parameter value of the characteristic points X1 or X2, they are mapped to the reference value zero.
21 -unipolar 2...10 V / 4...20 mA	If the characteristic points X1 or X2 have been set with a negative parameter figure or smaller than 20%, the input characteristic is mapped to the reference value 20%.
101 -Bipolar, absolute value	Negative parameter values of the characteristic points Y1 or Y2 are mapped as a positive reference value in the characteristic.

Further information on the operation modes stated in the table can be found in the following chapter "Examples".

4.1.4.1 Examples

The analog input signal is mapped onto a reference value as a function of the characteristic. The following examples show the operation modes for an analog voltage signal. The parameter *Minimum Frequency 418* is set to the value 0.00 Hz. The characteristic point 100% for the Y-axis corresponds to the parameter *Maximum Frequency 419* of 50.00 Hz in the examples.

Attention! The various operation modes change the input characteristic as a function of the parameterized characteristic points. In the following examples, the areas of the coordinate system from which a characteristic point is displaced are marked.

Operation mode "1 – bipolar"

In operation mode "1 – bipolar", the characteristic of the analog input can be freely set by stating two characteristic points.

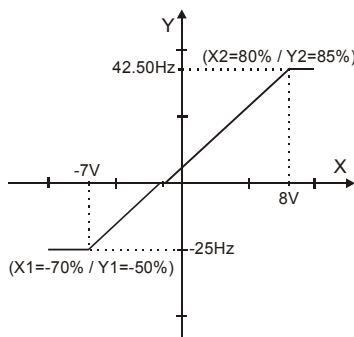

Characteristic point 1:

$$X1 = -70.00\% \cdot 10 \text{ V} = -7.00 \text{ V}$$

$$Y1 = -50.00\% \cdot 50.00 \text{ Hz} = -25.00 \text{ Hz}$$

Characteristic point 2:

$$X2 = 80.00\% \cdot 10 \text{ V} = 8.00 \text{ V}$$

$$Y2 = 85.00\% \cdot 50.00 \text{ Hz} = 42.50 \text{ Hz}$$

Tolerance band:

$$\Delta X = 2.00\% \cdot 10 \text{ V} = 0.20 \text{ V}$$

The change of direction of rotation is done in the example at an analog input signal of -1.44 V, with a tolerance band of ± 0.20 V.

Operation mode "11 – unipolar"

In operation mode "11 – unipolar", the characteristic points are displaced to the origin of the characteristics with a negative value for the X-axis.

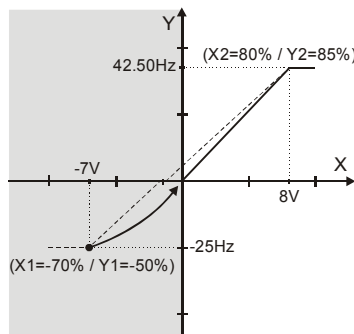

Characteristic point 1:

$$X1 = -70.00\% \cdot 10 \text{ V} = -7.00 \text{ V}$$

$$Y1 = -50.00\% \cdot 50.00 \text{ Hz} = -25.00 \text{ Hz}$$

Characteristic point 2:

$$X2 = 80.00\% \cdot 10 \text{ V} = 8.00 \text{ V}$$

$$Y2 = 85.00\% \cdot 50.00 \text{ Hz} = 42.50 \text{ Hz}$$

Tolerance band:

$$\Delta X = 2.00\% \cdot 10 \text{ V} = 0.20 \text{ V}$$

The characteristic point 1 has been displaced to the origin. The parameter *Tolerance band 560* is not taken into account in this example, as no change of sign of the reference frequency value takes place.

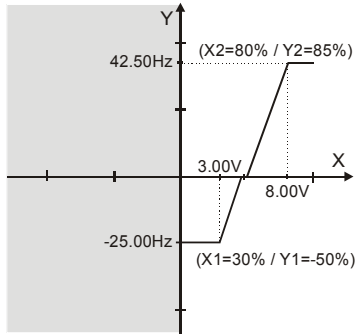

Characteristic point 1:

$$X1 = 30,00\% \cdot 10 \text{ V} = 3.00 \text{ V}$$

$$Y1 = -50,00\% \cdot 50.00 \text{ Hz} = -25.00 \text{ Hz}$$

Characteristic point 2:

$$X2 = 80,00\% \cdot 10 \text{ V} = 8.00 \text{ V}$$

$$Y2 = 85,00\% \cdot 50.00 \text{ Hz} = 42.50 \text{ Hz}$$

Tolerance band:

$$\Delta X = 2,00\% \cdot 10 \text{ V} = 0.20 \text{ V}$$

The change of direction of rotation is done in the example at an analog input signal of 4.85 V, with a tolerance band of $\pm 0.20 \text{ V}$.

Operation mode "21 – unipolar 2...10 V / 4...20 mA"

This operation mode limits the input characteristic to the range between 5% and 100% of the analog input signal. If the value for a characteristic point of the X-axis is outside 5%, it is mapped to the characteristic point (2 V / 0 Hz).

The characteristic point on the X axis is calculated according to the following formula:

$$\text{characteristic point X} = \text{parameter value X} \cdot (100,00\% - 20,00\%) + 20,00\%$$

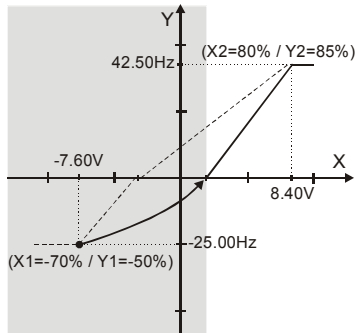

Characteristic point 1:

$$X1 = [-70,00\% \cdot (100,00\% - 20,00\%) + 20,00\%] \cdot 10 \text{ V} = -7.60 \text{ V}$$

$$Y1 = -50,00\% \cdot 50.00 \text{ Hz} = -25.00 \text{ Hz}$$

Characteristic point 2:

$$X2 = [80,00\% \cdot (100,00\% - 20,00\%) + 20,00\%] \cdot 10 \text{ V} = 8.40 \text{ V}$$

$$Y2 = 85,00\% \cdot 50.00 \text{ Hz} = 42.50 \text{ Hz}$$

Tolerance band:

$$\Delta X = [2,00\% \cdot (100,00\% - 20,00\%) \cdot 10 \text{ V}] = 0.16 \text{ V}$$

The characteristic point 1 has been displaced to the point (2.00V / 0.00 Hz). The parameter *Tolerance band 560* is not used in this example, as no change of sign of the reference frequency value takes place.

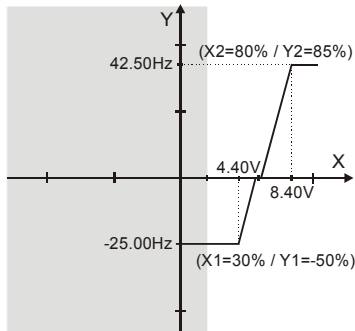

Characteristic point 1:

$$X1 = [30,00\% \cdot (100,00\% - 20,00\%) + 20,00\%] \cdot 10 \text{ V} = 4.40 \text{ V}$$

$$Y1 = -50,00\% \cdot 50.00 \text{ Hz} = -25.00 \text{ Hz}$$

Characteristic point 2:

$$X2 = [80,00\% \cdot (100,00\% - 20,00\%) + 20,00\%] \cdot 10 \text{ V} = 8.40 \text{ V}$$

$$Y2 = 85,00\% \cdot 50.00 \text{ Hz} = 42.50 \text{ Hz}$$

Tolerance band:

$$\Delta X = [2,00\% \cdot (100,00\% - 20,00\%) \cdot 10 \text{ V}] = 0.16 \text{ V}$$

The change of direction of rotation is done in the example at an analog input signal of 5.88 V, with a tolerance band of $\pm 0.16 \text{ V}$.

Operation mode "101 – bipolar absolute value"

The operation mode "101 – bipolar absolute value" maps the bipolar analog signal onto a unipolar input characteristic. The formation of the absolute takes the characteristic into account comparable to the "bipolar" operation mode, but the characteristic points are reflected on the X-axis with a negative value for the Y-axis.

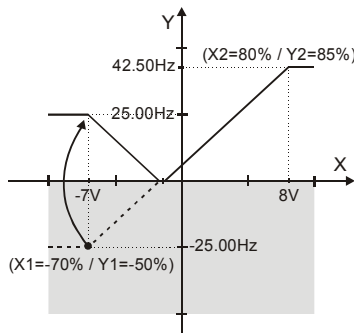

Characteristic point 1:
 $X1 = -70.00\% \cdot 10\text{ V} = -7.00\text{ V}$
 $Y1 = -50.00\% \cdot 50.00\text{ Hz} = -25.00\text{ Hz}$

Characteristic point 2:
 $X2 = 80.00\% \cdot 10\text{ V} = 8.00\text{ V}$
 $Y2 = 85.00\% \cdot 50.00\text{ Hz} = 42.50\text{ Hz}$

Tolerance band:
 $\Delta X = 2.00\% \cdot 10\text{ V} = 0.20\text{ V}$

In this example, the reference value is again increased from an analog input signal of -1.44 V with a tolerance band of $\pm 0.20\text{ V}$. The theoretical change of sign of the reference value is used and leads to the tolerance band stated. There is no change of the direction of rotation.

4.1.5 Scaling

The analog input signal is mapped to the freely configurable characteristic. The maximum admissible setting range of the drive mechanism is to be set according to the configuration selected via the frequency limits or the percentage value limits. In the parameterization of a bipolar characteristic, the minimum and maximum limit for both directions of rotation are taken over. The percentage values of the characteristic points are relative to the maximum limits selected.

Parameter		Setting		
No.	Description	Min.	Max.	Fact. sett.
418	Minimum Frequency	0.00 Hz	999.99 Hz	3.50 Hz
419	Maximum Frequency	0.00 Hz	999.99 Hz	50.00 Hz

The controls use the maximum value of the output frequency, which is calculated from the parameter *maximum frequency* **419** and the compensated slip of the drive mechanism. The frequency limits define the speed range of the drive mechanism and the reference percentage values supplement the scaling of the input characteristic according to the configured functions.

Parameter		Setting		
No.	Description	Min.	Max.	Fact. sett.
518	Minimum reference percentage	0.00 %	300.00 %	0.00 %
519	Maximum reference percentage	0.00 %	300.00 %	100.00 %

4.1.6 Tolerance band and hysteresis

The analog input characteristic with change of sign of the reference value can be adapted by the parameter *Tolerance band* **560** of the application. The tolerance band to be defined extends the zero crossing of the speed relative to the analog control signal. The percentage parameter value is relative to the maximum current or voltage signal.

Parameter		Setting		
No.	Description	Min.	Max.	Fact. sett.
560	Tolerance band	0.00 %	25.00 %	2.00 %

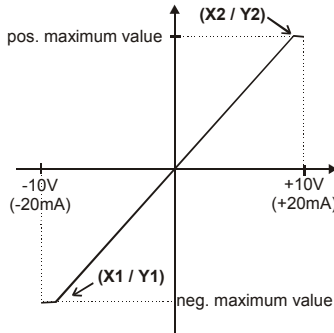

Without tolerance band

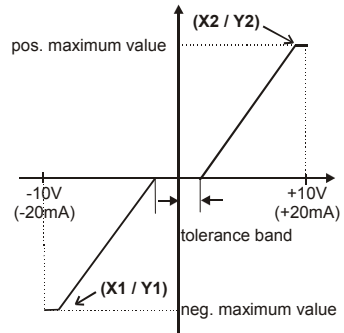

With tolerance band

The *Minimum Frequency* **418** or the *Minimum reference percentage* **518** set in the factory extends the parameterized tolerance band to the hysteresis.

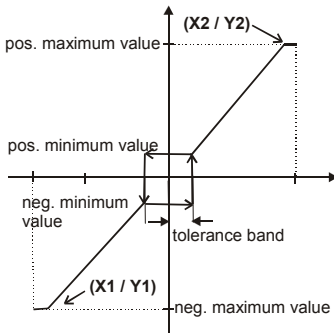

With tolerance band and minimum value

For example, the output variable resulting from the positive input signals is kept at the positive minimum value until the input signal is below the value for the tolerance band in a negative direction. After that proceed on the set characteristic.

4.1.7 Error and warning behavior

The monitoring of the analog input signal necessary according to the application is to be configured via the parameter *Error/Warning behavior* **563**.

Operation mode	Function
0 -Off	The input signal is not monitored.
1 -Warning < 1 V / 2 mA	If the input signal is less than 1 V or 2 mA, there is a warning message.
2 -Shutdown < 1V / 2 mA	If the input signal is less than 1 V or 2 mA, there is a warning message; the drive mechanism is decelerated according to stopping behavior 2.
3 -Fault switch-off < 1 V / 2 mA	If the input signal is less than 1 V or 2 mA, there is a warning and fault message and the drive mechanism stops freely.

The monitoring of the analog input signal is active independent of the release of the frequency inverter according to the operation mode selected.

In operation mode **2**, the drive mechanism is decelerated independent of the stopping behavior set (Parameter *Operation mode* **630**) according to stopping behavior 2 (shutdown and stop). If the set holding time has expired, there is a fault message. A repeat start of the drive mechanism is possible by switching the start signal on and off if the fault has been cleared.

Operation mode **3** defines the free stoppage of the drive mechanism, independent of the stopping behavior selected, which is stipulated with the parameter *Operation Mode* **630**.

Attention! Monitoring of the analog input signal via the parameter *Error/Warning Behavior* **563** demands a check of the characteristic parameters.

4.1.8 Adjustment

As a result of component tolerances, it can be necessary to adjust the analog input. Parameter *Adjustment* **568** is used for this purpose.

Operation mode	Function
0 -no adjustment	Normal operation
1 -Adjustment 0 V / 0 mA	Adjustment of the measurement with an analog signal of 0 V or 0 mA.
2 -Adjustment 10 V / 20 mA	Adjustment of the measurement with an analog signal of 10 V or 20 mA.

Example of the adjustment of the analog input with a voltage signal:

Note: The measurements for the adjustment are to be done with a suitable measuring instrument and the correct polarity.
If not, faulty measurements can result.
If an external voltage source is used for the adjustment, make sure to set the voltage/current values exactly as these values are saved as 0 V/0 mA and 10 V/20 mA.

- Apply 0 V to the analog input, e.g. with a wired link from the socket of the analog input X410B.4 to socket X210B.7 (earth/GND) of the frequency inverter.
- Select operation mode "1 - Adjustment 0 V / 0 mA".
- Apply 10 V to the analog input, e.g. with a wired link from the socket of the analog input to socket X210B.5 (reference output 10 V) of the frequency inverter.
- Select operation mode "2 - Adjustment 10 V / 20 mA".

This completes the adjustment of the analog input.

4.1.9 Filter time constant

The time constant of the filter for the reference analog value can be set via the parameter *Filter time constant* **561**.

The time constant states the time for which the input signal is averaged by means of a low pass filter, e.g. in order to eliminate fault effects.

The setting range is a range of values between 0 ms and 5000 ms in 15 steps.

Operation mode	Function
0 -Time constant 0 ms	Filter deactivated – analog reference value is forwarded unfiltered
2 -Time constant 2 ms	Filter activated – averaging of the input signal via the set value of the filter time constants
4 -Time constant 4 ms	
8 -Time constant 8 ms	
16 -Time constant 16 ms	
32 -Time constant 32 ms	
64 -Time constant 64 ms	
128 -Time constant 128 ms	
256 -Time constant 256 ms	
512 -Time constant 512 ms	
1000 -Time constant 1000 ms	
2000 -Time constant 2000 ms	
3000 -Time constant 3000 ms	
4000 -Time constant 4000 ms	
5000 -Time constant 5000 ms	

4.2 Analog output EM- S1OUTA

4.2.1 General

The analog output of the EM-ENC-04 expansion module is a voltage output with a range of +/-10 V. Parameterization of the output signals is done by the definition of the operation mode and a linear characteristic, stating the offset and the amplification.

4.2.2 Operation modes

The operation mode of the analog output is selected via the parameter *Operation mode* **584**.

Additional to the operation modes listed, those stated in the operating instructions of the frequency inverter in the chapter "Analog output MFO1A" also apply.

Operation mode	Function
0 -Off	Analog output switched off, 0 V fixed voltage for the adjustment
41 -EM-S1INA, absolute value	Signal absolute value on the analog input EM-S1INA, between 0.0 V...10.0 V
100 -10 V	10 V fixed voltage for the adjustment
101 bis 133, 141	Operation modes 1 to 33 and 41 with sign, between -10.0 V...10.0 V
201 to 254	Operation modes 1 to 54; Absolute actual value between 2.0 V...10.0 V

4.2.3 Adjustment

As a result of component tolerances, it can be necessary to adjust the analog output. Parameter *Adjustment* **587** is used for this purpose.

Parameter		Setting		
No.	Description	Min.	Max.	Fact. sett.
587	Adjustment	-15.00 V	15.00 V	0.00 V

Example of the adjustment of the analog output:

Note: The measurements for the adjustment are to be done with a suitable measuring instrument and the correct polarity.
The order shown in the example is to be complied with during the adjustment.
If not, faulty measurements and settings can result.

- Select operation mode "0 – Off" for the parameter *Operation mode* **584**.
- Enter the voltage measured on the output in the parameter *Adjustment* **587**.
- Select operation mode "100 - 10 V" for parameter *Operation mode* **584**.
- Enter the voltage measured on the output in the parameter *Adjustment* **587**.
- Select operation mode "0 – Off" on the parameter *Operation mode* **584**. In case the voltage measured at the output deviates from 0 V significantly, carry out the adjustment procedure again.

Note: The greatest precision to be achieved is approx. +/-40 mV.

- Select the required operation mode of the analog output for parameter *Operation mode* **584**.

4.2.4 Zero adjustment and amplification

After the adjustment has been carried out, the voltage of the output signal at 0% and 100% of the reference signals can be set with the parameters *Offset* **585** (zero adjustment) and *Amplification* **586**.

The zero adjustment with the parameter *Offset* **585** is done specific to the application as a percentage of the final value of the analog output (10 V).

Via the parameter *Amplification* **586** the amplification can be set as a percentage of the final value of the analog output (10 V).

In the factory setting, the zero point has been set at 0% Offset, i.e. minimum value of the reference signal equal to 0 V output signal. The factory setting amplification equal to 100% means that the output signal is 10 V when the reference value is reached.

Parameter		Setting		
No.	Description	Min.	Max.	Fact. sett.
585	Offset	-100.00 %	100.00 %	0.00 %
586	Amplification	5.0 %	1000.0 %	100.0%

4.2.4.1 Examples

The actual value parameter is mapped to the analog output signal as a function of the selected parameters *Offset* **585** and *Amplification* **586**. The following examples show the application-specific adaptation for an analog voltage signal.

Example 1:

Parameter		Setting
No.	Description	Example
585	Offset	0.00 %
586	Amplification	1000.0 %

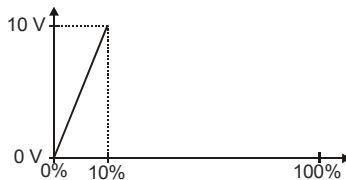

The setting of the parameter *Offset* **585** to 0.00% and the parameter *Amplification* **586** to 1000.0% means that the output signal:

- is 0 V at 0% of the reference signal,
- is 10 V at 10% of the reference signal.

Example 2:

Parameter		Setting
No.	Description	Example
585	Offset	-5.00 %
586	Amplification	100.0 %

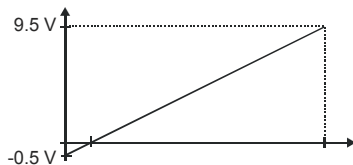

The setting of the parameter *Offset* **585** to -5,00% and the parameter *Amplification* **586** to 100,0% means that the output signal:

- is -0.5 V at 0% of the reference signal,
- is 9.5 V at 100% of the reference signal.

4.3 Digital output EM-S10UTD

4.3.1 General

The digital output of the EM-ENC-04 expansion module is designed as a relay with normally open contacts. Parameterization of this digital output permits a linking to a variety of functions. The selection of functions depends on the parameterized configuration.

4.3.2 Operation modes

The operation mode of the digital output (Sockets X410B.5 and X410B.6) is selected via the parameter *Operation Mode EM-S10UTD* **533**.

The selectable operation modes correspond to the table shown in the operating instructions of the frequency inverter in the chapter "Digital outputs".

4.4 Speed sensor input EM-ENC

The six speed sensor inputs of the EM-ENC-04 expansion module can be set via the parameter *Operation mode Speed sensor 2* **493** and selection of the corresponding operation mode for the evaluation of a unipolar 24V two-channel speed sensor (incremental speed sensor) with reference impulse.

Operation mode	Function
0 -Off	Speed measurement not active
4 -Quadruple evaluation	Two-channel speed sensor with recognition of direction of rotation via track signals A and B; four signal edges are evaluated per division mark.
104 -Quadruple evaluation inverted	Like operation mode 4; the actual speed value is inverted (alternatively to exchanging the track signals).
1004 -Quadruple evaluation -with reference impulse	Two-channel speed sensor with recognition of direction of rotation via track signals A and B; four signal edges are evaluated per division mark. The reference impulse is used for speed sensor monitoring.
1104 -Quadruple evaluation -inverted with reference impulse	Like operation mode 1004; the actual speed value is inverted (alternatively to the exchange of the track signals).

Unlike the standard sockets available according to specification RS-422A / RS-485, the interface is suitable for a 5 V push-pull signal.

Terminal assignment of the inputs:

Socket X410A	
Socket	input
(1): X410A.1	Speed sensor input EM-ENC track A+
(2): X410A.2	Speed sensor input EM-ENC track A-
(3): X410A.3	Speed sensor input EM-ENC track B+
(4): X410A.4	Speed sensor input EM-ENC track B-
(5): X410A.5	Speed sensor input EM-ENC reference signal Z+
(6): X410A.6	Speed sensor input EM-ENC reference signal Z-

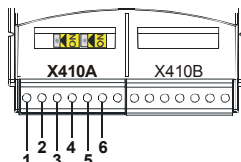

4.4.1 Termination resistor

The termination resistor of 150 Ω for the speed sensor of the EM-ENC-04 speed sensor is deactivated by default.



Caution! The termination resistor may only be activated for a 5 V push-pull signal according to specification RS-422A / RS-485. For activating the termination resistor, **both** slide switches **S2** must be switched to position "ON". Switching of the two slide switches to different positions may destroy components. If an unipolar speed sensor is used, e.g. with a 24V signal, no termination resistor is required.

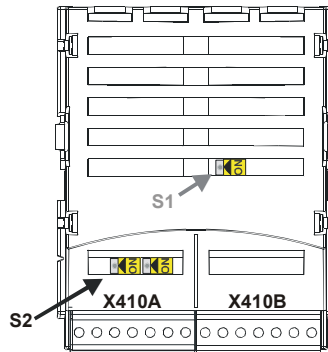

Operation mode of switches S2		Function
OFF -	no termination resistor	OFF (to the right)
ON -	Termination resistor	ON (to the left)

Note: Switch **S1** enables switching the analog input to voltage signal or current signal (described in chapter "Analog Input EM-S1INA").

4.4.2 Division marks speed sensor 2

The number of increments of the connected speed sensor can be parameterized via the parameter *Division marks speed sensor 2* **494**. The number of division marks of the speed sensor is to be selected according to the speed range of the application. The maximum number of division marks S_{\max} is defined by the limit frequency of $f_{\max} = 300$ kHz of the speed sensor inputs EM-ENC (track A) and EM-ENC (track B).

$$S_{\max} = 300000 \text{ Hz} \cdot \frac{60 \text{ s / min}}{n_{\max}} \quad n_{\max} = \text{Max. speed of the motor in RPM}$$

To ensure a good true running of the drive mechanism, a sensor signal must be evaluated at least every 2 ms (signal frequency $f = 500$ Hz). The minimum number of division marks S_{\min} of the incremental speed sensor for a required minimum speed n_{\min} can be calculated from this requirement. The evaluation of four signal edges per mark is firmly defined in the function of speed sensor 2.

$$S_{\min} = 500 \text{ Hz} \cdot \frac{60 \text{ s / min}}{A \cdot n_{\min}} \quad \begin{array}{l} n_{\min} = \text{Min. speed of the motor in RPM} \\ A = 4 \text{ (quadruple evaluation)} \end{array}$$

Parameter		Setting		
No.	Description	Min.	Max.	Fact. Sett.
494	Division marks speed sensor 2	1	8192	1024

4.4.3 Level

Via the parameter *Operation mode Level* **495**, the following operation modes can be selected:

Operation mode	Function
0 - push-pull	Push-pull signals (5 V) are evaluated (according to specification RS-422A/RS-485).
2 - unipolar	Unipolar signals (10 V...24 V) at A+ and B+ are evaluated.

4.4.4 Actual speed source

If speed sensor 2 of the expansion module is configured to supply the actual value signal for the speed controller, speed sensor 2 must be selected as the source. Switch-over is affected via parameter *Actual Speed Source* **766**. By default, speed sensor 1 is used as the actual speed source.

Operation mode	Function
1 -Speed sensor 1	The actual speed source is speed sensor 1 of the basic device (factory setting).
2 -Speed sensor 2	The actual speed source is speed sensor 2 of the EM-ENC-04 expansion module.

4.4.5 Actual value comparison

The expansion module provides additional operation modes for parameters *Operation Mode Comparator 1* **540** and *Operation Mode Comparator 2* **543** which are described in the operating instructions. These operation modes permit a comparison of the speed frequency of speed sensor 2 with a maximum speed and a comparison of the analog input EM-S1INA with a maximum analog input value.

Operation mode	Function
8 -Abs. Actual speed 2	<i>Speed Sensor 2 Speed</i> 220 > maximum speed (calculated from <i>Maximum Frequency</i> 419 and <i>No. of Pole Pairs</i> 373)
16 -EM-S1INA absolute value 108 and 116	<i>Analog input EM-S1INA</i> 253 > analog input 100% Operation modes with signs (+/-)

4.5 Frequency and percentage reference channel

The varied functions for the specification of the reference values are connected in the various configurations by the frequency or percentage reference channel. The *Reference frequency source* **475**, and the *Reference percentage source* **476** determine the additive connection of the available reference sources as a function of the installed hardware.

Operation mode	Function
2 - EM-S1INA, absolute value	Reference source is the analog input EM-S1INA.
4 - MFI1A + EM-S1INA, absolute value	Reference sources are the multifunctional input MFI1A and the analog input EM-S1INA.
12 - EM-S1INA + FF (and/or FP), absolute value	Reference sources are the analog input EM-S1INA and fixed frequency FF (and/or the fixed percentage FP).
14 - MFI1A + EM-S1INA + FF (and/or FP), absolute value	Reference sources are the multifunctional input MFI1A, analog input EM-S1INA and fixed frequency FF (and/or the fixed percentage FP).
22 - EM-S1INA + MP, absolute value	Reference sources are the analog input EM-S1INA and the motor potentiometer function MP.
24 - MFI1A + EM-S1INA + MP, absolute value	Reference sources are the multifunctional input MFI1A, analog input EM-S1INA and the motor potentiometer function MP.
34 - speed sensor 2 (F2), absolute value	The frequency signals in <i>Operation mode Speed sensor 2</i> 493 are evaluated as a reference value.
35 - MFI1A + F2, absolute value	Reference sources are the multifunctional input MFI1A and the frequency signals in <i>Operation Mode Speed Sensor 2</i> 493 .
102 to 135	Operation modes with signs (+/-)

Additional to the operation modes listed, those stated in the operating instructions of the frequency inverter in the chapter "Frequency reference channel", and in the chapter "Percentage reference channel" also apply.

4.6 Actual value display



The actual values of speed sensor 2 can be read via the parameters *Frequency speed sensor 2* **219** and *Speed, speed sensor 2* **220**.

The analog input signal on analog input EM-S1INA can be a voltage or a current signal depending on the setting of switch **S1**. Accordingly, the actual value parameter *Analog input EM-S1INA* **253** is displayed as a percentage.

The analog output signal on analog output EM-S1OUTA can be read via the actual value parameter *Analog output EM-S1OUTA* **266**.

5 Parameter list









The parameter list is structured according to the menu branches of the control unit. For better clarity, the parameters are marked with pictograms:

-  The parameter is available in the four data sets.
-  The parameter value is set by the SETUP routine.
-  This parameter cannot be written in the operation of the frequency inverter.

5.1 Actual value menu (VAL)

Actual values of the machine				
No.	Description	Unit	Display range	Chapter
219	Frequency speed sensor 2	Hz	0.0 ... 999.99	4.6
220	Speed, speed sensor 2	rpm	0 ... 60000	4.6
Actual values of the frequency inverter				
253	Analog input EM-S1INA	%	-100 ... +100	4.6
266	Analog output EM-S1OUTA	V	-10.0 ... +10.0	4.6

5.2 Parameter menu (PARA)

Speed sensor 2 EM-ENC				
No.	Description	Unit	Setting range	Chapter
 493	Operation mode speed sensor 2	-	Selection	4.4
 494	Division marks speed sensor 2	-	1 ... 8192	4.4.2
495	Level	-	Selection	4.4.3
Digital output EM-S1OUTD				
533	Operation mode EM-S1OUTD	-	Selection	4.3.2
Analog input EM-S1INA				
 560	Tolerance band	%	0.00 ... 25.00	4.1.6
561	Filter time constant	ms	Selection	4.1.9
562	Operation mode	-	Selection	4.1.4
563	Error/warning behavior	-	Selection	4.1.7
 564	Characteristic point X1	%	-100.00 ... 100.00	4.1.3
 565	Characteristic point Y1	%	-100.00 ... 100.00	4.1.3
 566	Characteristic point X2	%	-100.00 ... 100.00	4.1.3
 567	Characteristic point Y2	%	-100.00 ... 100.00	4.1.3
568	Adjustment	-	Selection	4.1.8
Analog output EM-S1OUTA				
584	Operation mode	-	Selection	4.2.2
585	Offset	%	-100.00 ... 100.00	4.2.4
586	Amplification	%	5.0 ... 1000.0	4.2.4
587	Adjustment	V	-15.00 ... 15.00	4.2.3
Speed controller				
 766	Actual speed source	-	Selection	4.4.4

6 Annex

6.1 Error messages

The various control functions and methods and the hardware of the frequency inverter contain functions, which continuously monitor the application. As a supplement to the messages documented in these operating instructions, the following failure keys are activated by the EM-ENC-04 expansion module.

Control connections		
F14	02	Reference value signal on analog input EM-S1INA faulty, check signal.
	30	Speed sensor signal is faulty, check connections
	31	One track of the speed sensor signal is missing, check connections.
	32	Direction of rotation of speed sensor wrong, check connections.
	33	Speed sensor 2, divisions marks wrong, check speed sensor
	34	Division marks of speed sensor signal 2 too low, check speed sensor.
	35	Division marks of speed sensor signal 2 too high, check speed sensor.

Additional to the listed fault messages, there are further fault messages for internal purposes and not listed here. If you receive fault messages, which are not listed here, please contact us by phone.



Bonfiglioli has been designing and developing innovative and reliable power transmission and control solutions for industry, mobile machinery and renewable energy applications since 1956.

www.bonfiglioli.com